

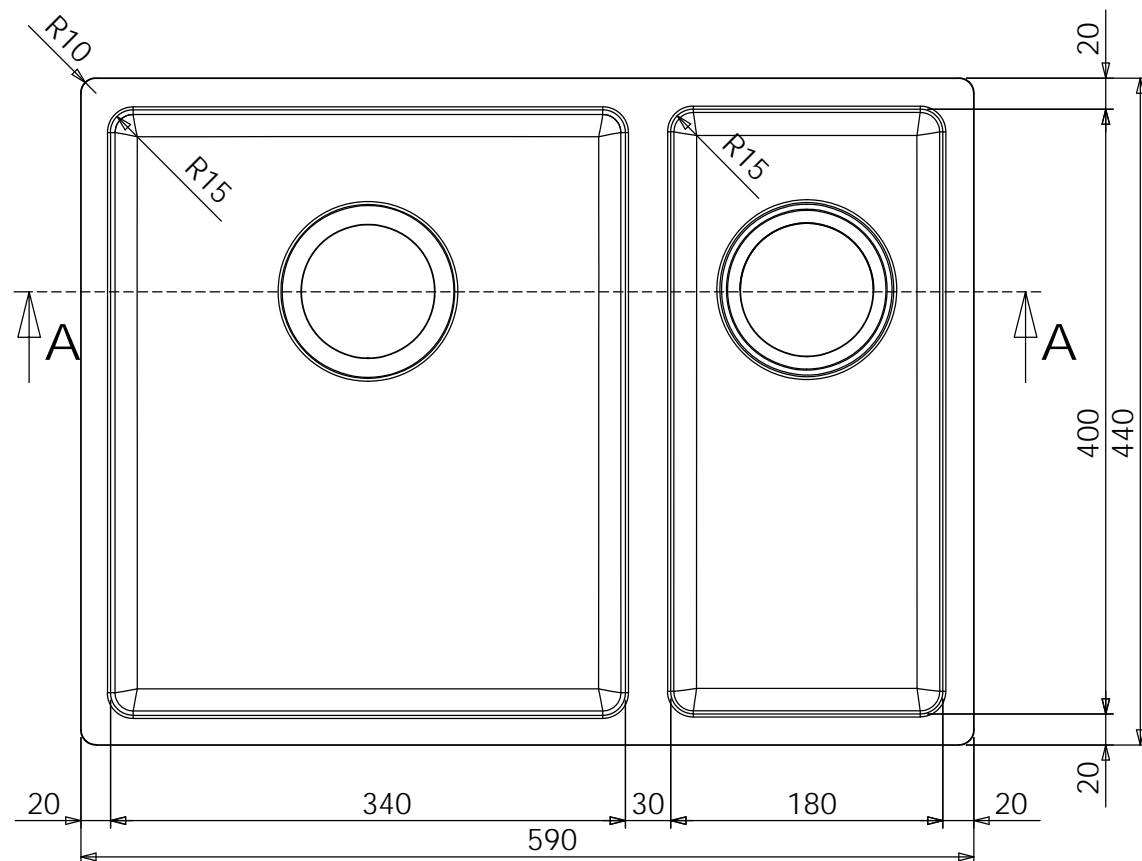

SEZIONE A-A

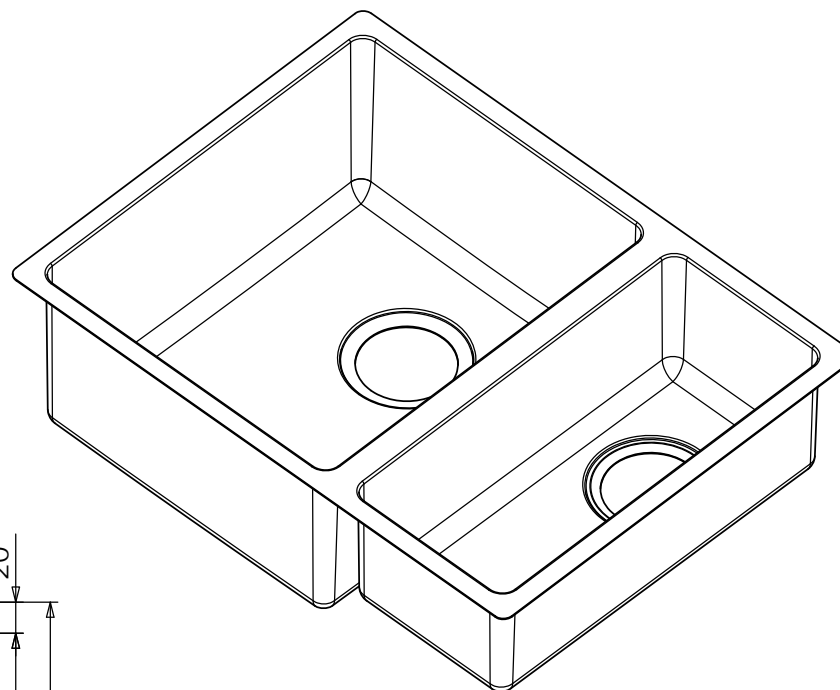

ATTENZIONE:
 VASCA ACCOPPIATA:
 VASCA 340X400 H. 200 R15
 VASCA 180X400 H. 140 R15
 SP. 1,0 mm
 FORI 115/88 CENTRALI
 LATO CORTO
 FINITURA:
 INTERNO - TAMPICO
 BORDO - SCOTHC BRITE PARALLELO LATO LUNGO
 ESTERNO - DECAPATO

TOLLERANZA +/- 1 mm

VASCA ACCOPPIATA 340X400 - 180X400

NR. DISEGNO MORI	VAAC 12	CODICE MORI	VAAC34/18R15
DATA:	14/05/2013		
MATERIALE:	AISI 304		
CLIENTE:	STANDARD MORI	SCALA:	FOGLIO 1 DI 1